

THE WRIGHT GLIDER 1902

HERE' S A FUN, IF CHALLENGING, PAPER MODEL OF
THE WRIGHT BROTHER 1902 GLIDER.
THIS WAS THE LAST GLIDER THAT THE BROTHERS BUILT
BEFORE BUILDING THE FIRST AIRPLANE
THE FOLLOWING YEAR.

IT WAS PROVIDED AS A FREE PREMIUM
SEVERAL YEARS AGO BY
WWW.FIDDLERSGREEN.NET

THIS IS A GREAT SOURCE FOR ALL KINDS OF PAPER MODELS,
ESPECIALLY AIRPLANES!

IF YOU GO TO THEIR WEB SITE AND REGISTER,
YOU WILL BE ALLOWED TO DOWNLOAD
THREE PAPER MODEL INSTRUCTIONS
FOR FREE!

(KIDS, ALWAYS GET YOUR PARENTS' PERMISSION!)

THEY EVEN HAVE A MODEL OF
THE WRIGHT BROTHERS FLYER OR 1903,
THE FIRST REAL AIRPLANE!

REALLY A GREAT DEAL!

WRIGHT GLIDER

THIS LAST NON-POWERED
VERSION MADE MANY
FLIGHTS IN
1902

THE
1902

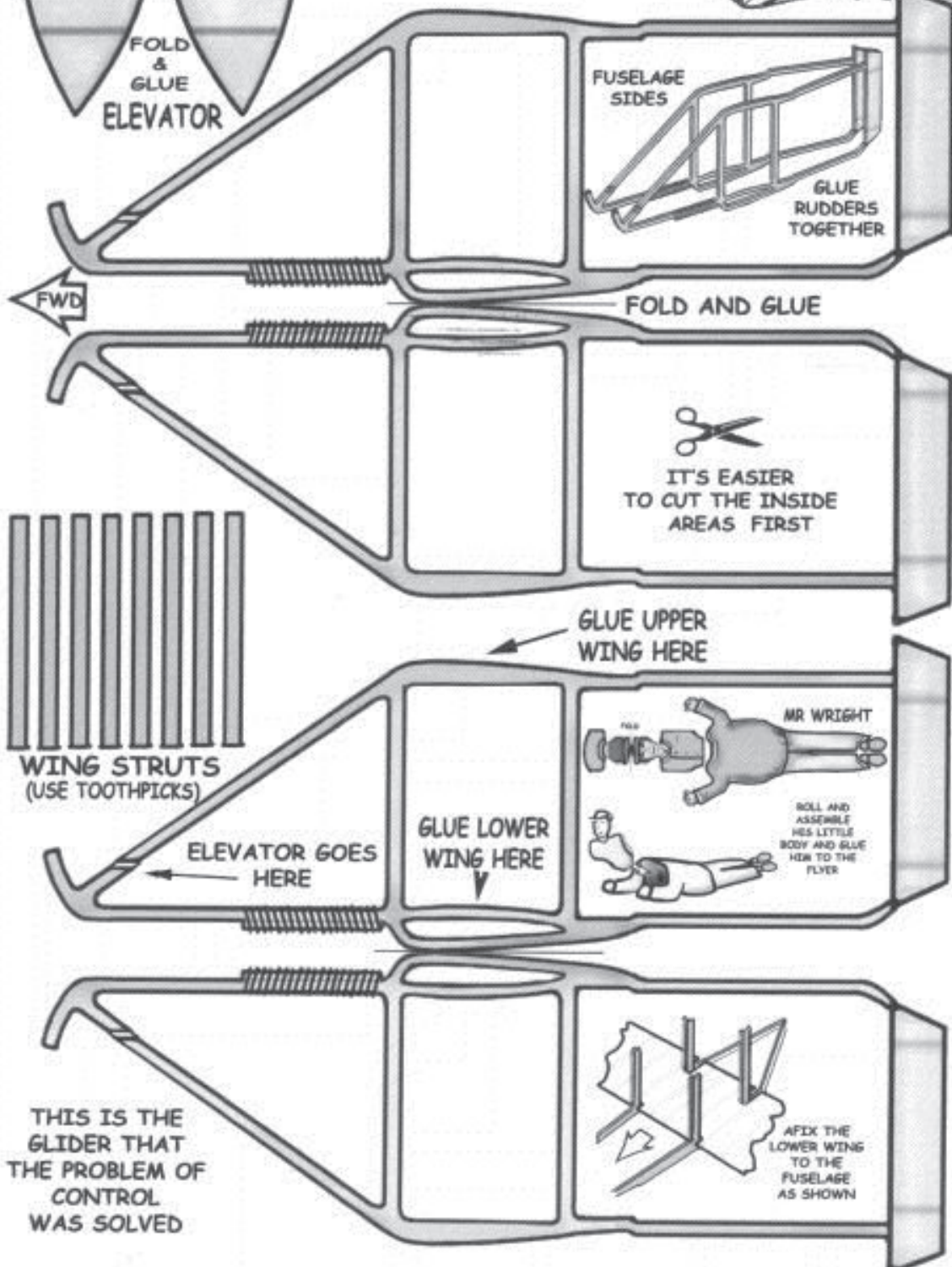
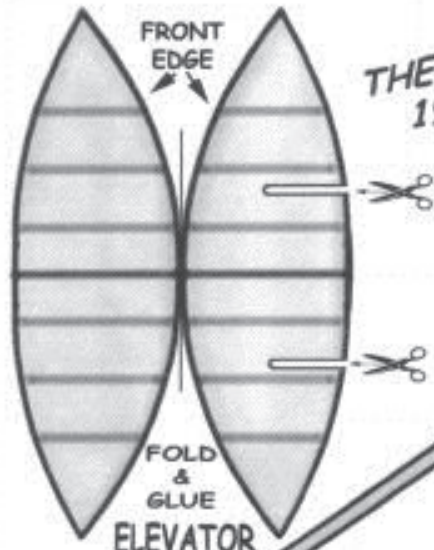

THIS IS THE
GLIDER THAT
THE PROBLEM OF
CONTROL
WAS SOLVED

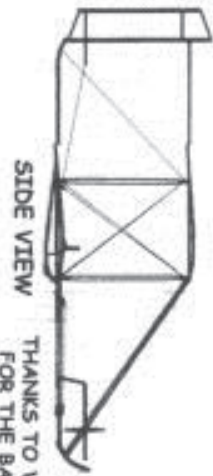

THANKS TO WWW.WRIGHT-BROTHERS.ORG
FOR THE BASIC THREE VIEW DRAWINGS

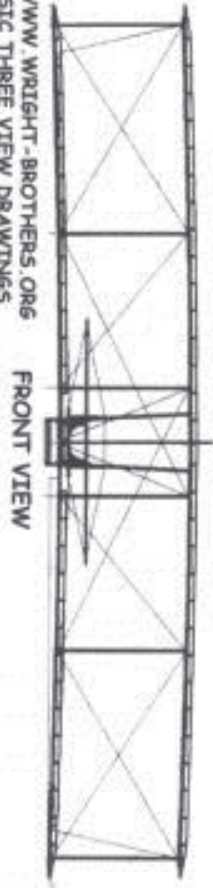

SHEET TWO

BOTTOM WING

FOLD & GLUE

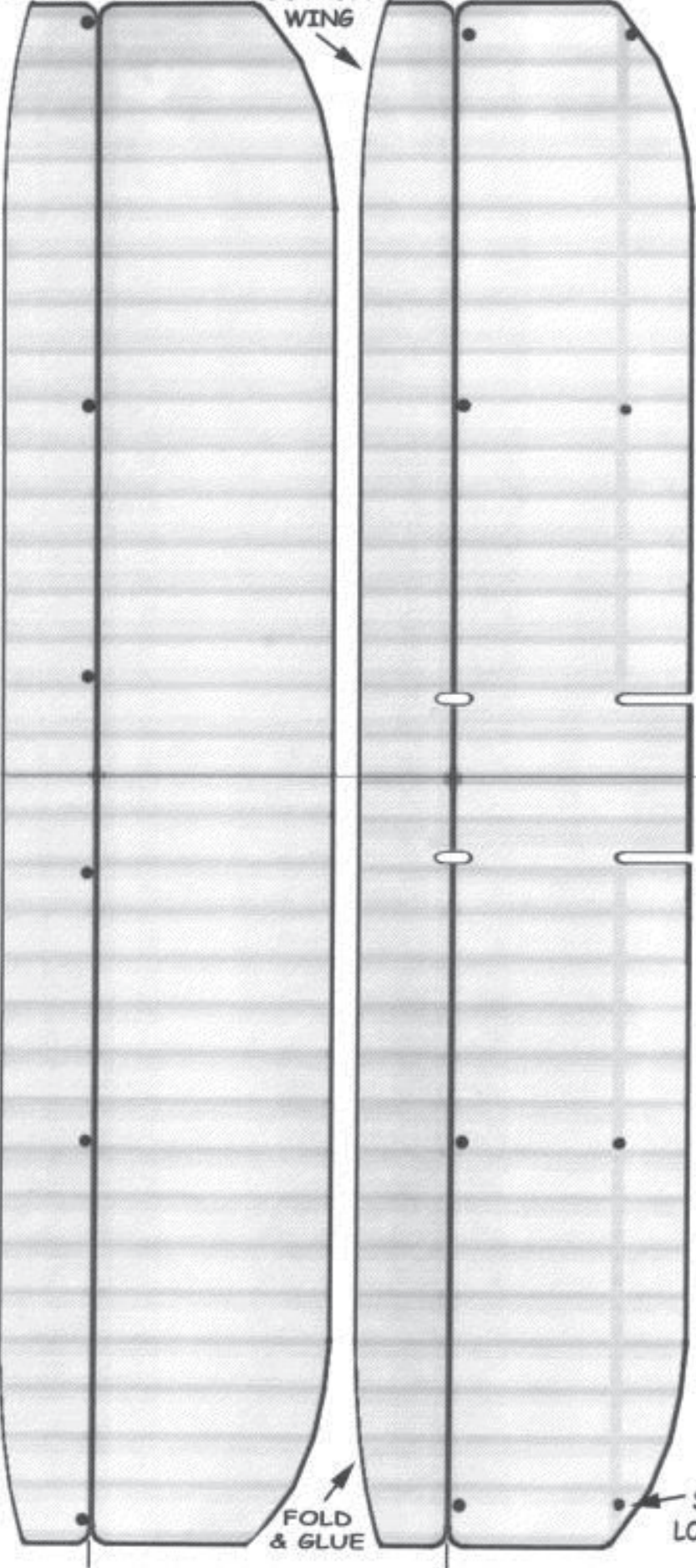

FOLD & GLUE

STRUT LOCATION

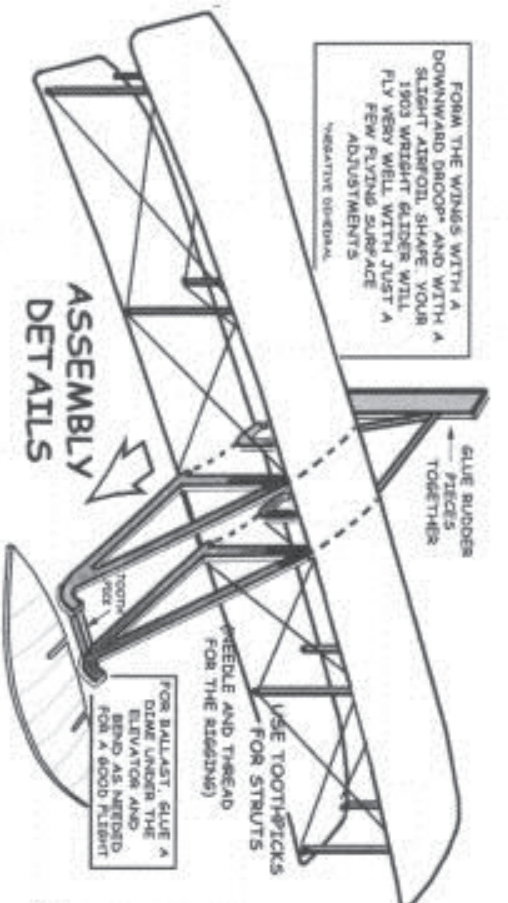

ASSEMBLY DETAILS

FORM THE WINGS WITH A DOWNWARD BICOOP AND WITH A SLIGHT AIRFOIL SHAPE. YOUR 1902 WRIGHT GLIDER WILL FLY VERY WELL WITH JUST A FEW FLUID SURFACE ADJUSTMENTS.
NEGATIVE DIRECTION

GLUE RUBBER PIECES TOGETHER

FOR BALLAST, GLUE A DIME UNDER THE ELEVATOR AND FOR A GOOD FLIGHT

USE TOOTHPICKS FOR STRUTS
NEEDLE AND THREAD FOR THE STRUTS

1902 WRIGHT GLIDER

SHEET TWO

MUCH MORE INFO ABOUT THE GLIDER: FIDDLERSGREEN.NET

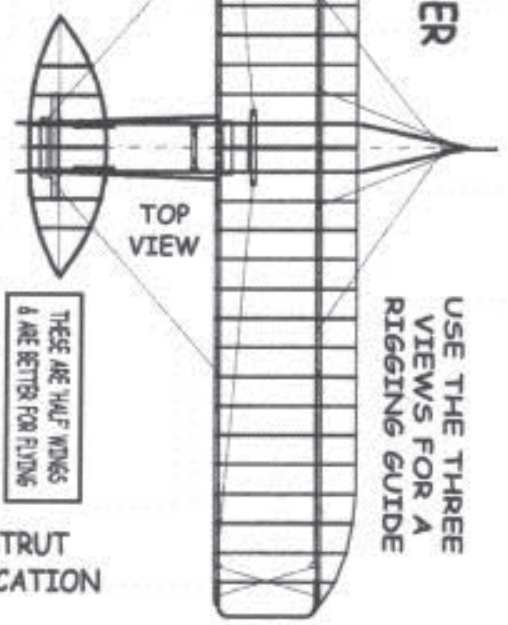

TOP VIEW

THESE ARE HALF WINGS & ARE BETTER FOR FLYING

USE THE THREE VIEWS FOR A RIGGING GUIDE